

Pro Series

Interactive Flat Panel for Enterprise

Our complete enterprise solution is easy to use, simple to install, will work with your current system set up and is designed for over 50,000 hours of use. With low maintenance and no ongoing subscriptions, Clevertouch provides the only complete all in one solution for Enterprise.

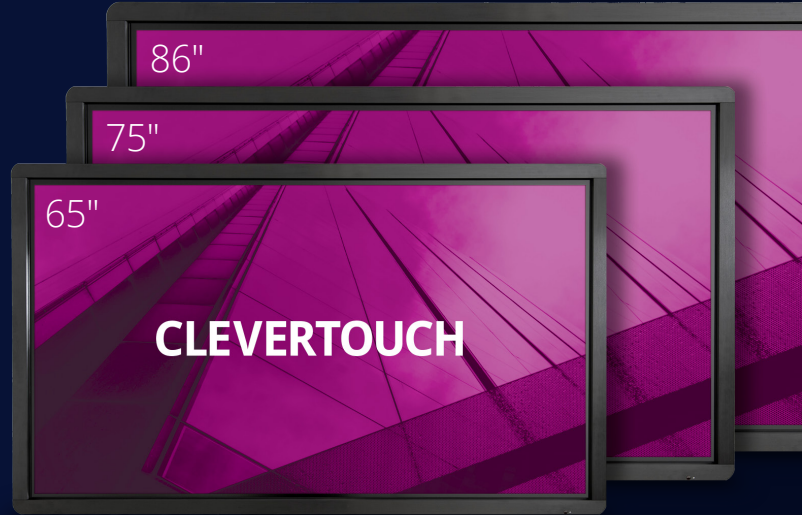

The award winning all-in-one solution for an immersive workspace experience



Display Technology for Collaboration and Conferencing
InAVation Awards 2018 – Winner



Manufacturer of the Year
AV Awards 2015 – Winner



Collaboration Product of the Year
Install Awards 2018 – Finalist



Share content from any device

Clevershare App is free to download and compatible with Android, Windows, iOS and Chrome devices. Up to 50 devices can connect with the Clevertouch screen and share content – images, video, and audio.



Networking and security

Our touchscreens are designed to integrate with your current system set up and work with your current software. With remote management tools, increased security and network options, and the most comprehensive warranty on the market, Clevertouch offers long-term savings and increased return on investment.



A natural and fluid writing experience

Our Super Glide Surface technology provides a natural and fluid writing experience with no lag, reminiscent of a pen and whiteboard. Erase with your palm. Pinch and pull to zoom. Switch between finger-touch, pen, and dual-pen instantly without needing to alter settings.



Send messages, alerts, announcements and media to all of your Clevertouch screens remotely

With Clever Message send dynamic messages to your Clevertouch screens. Your IT department or office can create messages for 24/7 use with live alerts and announcements.

Our Partners

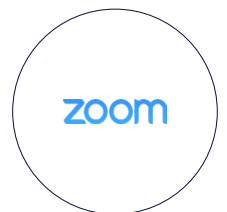
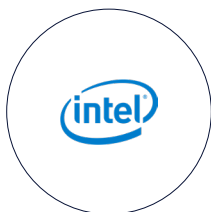
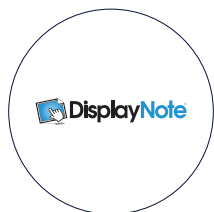

Connecting people with technology

Pro Series 2018 v.1

NEW

Remote management

Control all your screens, run diagnostics and shut down from a single device.

NEW

Super glide surface

Smooth glass for a fluid writing experience.

Compatibility

Compatible with **Windows**, **Mac OS X**, **MacOS** and **Chromebook**.

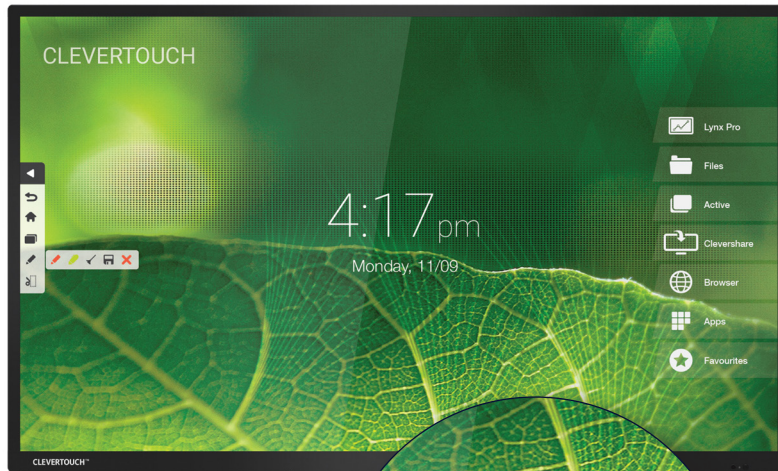

NEW

Video conferencing

Access Zoom, Skype for Business or Mosaic.

NEW

Cloud accounts

Connect instantly to your Google Drive or OneDrive accounts.

NEW

Smart personalized account profile

COMING SOON

Access your settings and files from your NFC key fob on any screen.

Clevertouch Features



Fully customizable



Local team with expert knowledge



Comprehensive warranty



20-point touch



Energy efficient



No software subscription fees



4K resolution display



Smart personalized profile



Remote management



OTA (Over the air) updates



Integrated speakers



Compatible with existing hardware and software



LUX user interface



No shadow



Anti-glare glass



HDMI, VGA, RS232 and USB connectivity



Optimal performance



Super glide surface

Pro Series Range

	Capacitive Touch	E-CAP	High Precision
Dual pen functionality - Combine dual colour styluses	✓	✓	✓
LUX business user interface	✓	✓	✓
Clevershare 2.0	✓	✓	✓
Clevercable	✓	✓	✓
Clever Message	✓	✓	✓
Pressure sensitive precise active styluses - The perfect solution for creative design	✓	✓	
Slim and lightweight		✓	
Simultaneous writing gesture control and palm recognition	✓	✓	
NFC smart personalised account profiles		✓	✓
Super glide surface		✓	✓
True bonded capacitive technology - The ultimate interactive technology	✓		
Sleek edge-to-edge design	✓		

Clever Message

NEW

24/7 digital signage

Turn your Clevertouch into an interactive digital signage kiosk.

Branded power-up screen

Get your organization's daily news when you power-up each day.

Live video streaming

Broadcast live or pre-recorded audio and video to your screens.

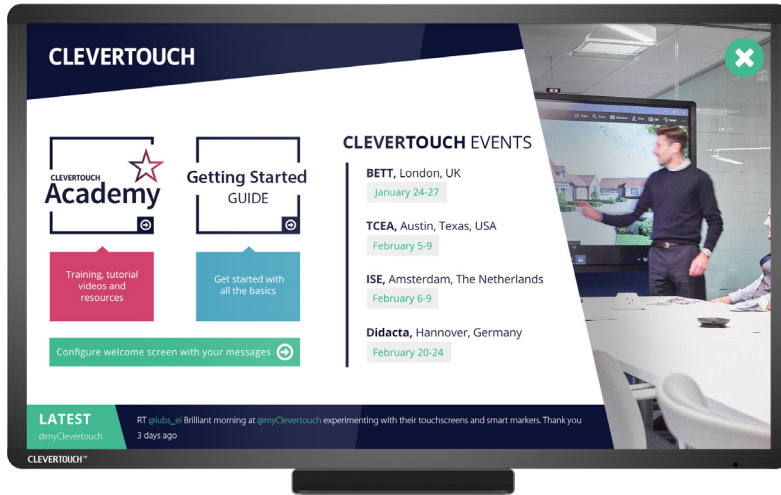

Instant messaging

Send instant or timed messages to any of your Clevertouch screens remotely.

Alerts

Send important announcements at the touch of a button.

Group your screens

Send messages to groups of Clevertouch displays simultaneously.

Clever Message Features



Add your logo



Customise with your colours



Add images and slideshows

RSS

Create RSS feeds



Live video messages



Add video and movies



Insert documents (pdf, word)



Add web pages



Touch Compatible



Add clocks with date and time



Add sound



Add text boxes



Create animations



Schedule timed messages



Choose from hundreds of themed templates



Assign zones to different staff or departments



Create groups of screens



Works over multiple locations

	65" Pro Series E-CAP 15465PROECAP	75" Pro Series E-CAP 15475PROECAP	86" Pro Series E-CAP 15486PROECAP	65" Capacitive Touch 15465CAP
Product Code				
Display				
Screen Type	LED	LED	LED	LED
Aspect Ratio	16:09	16:09	16:09	16:09
Resolution	4K Ultra HD	4K Ultra HD	4K Ultra HD	4K Ultra HD
Backlight	E-LED	E-LED	E-LED	E-LED
Brightness (cd/m ²)	350	350	350	350
Response Time	8ms	8ms	8ms	8ms
Audio	2 x 12W	2 x 12W	2 x 12W	Mid 1x12W; Bass 2x12W
Android	✓	✓	✓	✓
Glass	Anti Glare	Anti Glare	Anti Glare	Anti Glare
Super Glide Surface	✓	✓	✓	✓
Contrast Ratio	4000:1	4000:1	4000:1	4000:1
Interactive System				
Touch Points	20	20	20	20
Sensor Type	IR & EMR	IR & EMR	IR & EMR	P-Cap & EMR
Minimum Object Size (mm)	IR 6 & EMR 2	IR 6 & EMR 2	IR 6 & EMR 2	Touch <2 & EMR 0.5
Response Time (Touch)	< 15ms	< 15ms	< 15ms	N/A
Connectivity				
USB 2.0 / 3.0 / Touch	2 / 2 / 1	2 / 2 / 1	2 / 2 / 1	8 / 2 / 1
HDMI 1.4 In / 2.0 in	0 / 2	0 / 2	0 / 2	1 / 1
DisplayPort in	0	0	0	0
VGA Input	1	1	1	1
HDMI Out	1	1	1	1
CVBS (requires a 3.5mm to 3 x phono socket, not included)	✓	✓	✓	✓
PC-Audio	✓	✓	✓	✓
VGA Output	✗	✗	✗	✗
LAN (RJ45)	✓	✓	✓	✓
RS232	✓	✓	✓	✓
Module Slots	2	2	2	2
Power				
Power	300W	300W	400W	250W
Power (in standby)	<0.5W	<0.5W	<0.5W	<0.5W
EU Energy Rating - Efficiency Class	B	A	A	TBD
Physical Specifications				
Dimensions W x H x D (mm / ")	1508 x 902 x 75 / 59 3/8 x 35 33/64 x 2 61/64	1753 x 1022 x 75 / 69 1/64 x 40 15/64 x 2 61/64	1978 x 1166 x 75 / 77 7/8 x 45 29/32 x 2 61/64	1505 x 882 x 62 / 59 1/4 x 34 23/32 x 2 7/16
Weight	45kg / 99lb 3oz	70kg / 154lb 5oz	83.85kg / 184lb 14oz	49kg / 165lb 6oz
VESA (mm / ")	600 x 200 / 23 5/8 x 15 3/4	600 x 200 / 23 5/8 x 15 3/4	600 x 200 / 23 5/8 x 15 3/4	600 x 230 / 23 5/8 x 9 1/16
Android Capabilities				
Remote Management (MDM)	✓	✓	✓	✓
Instant updates (OTA)	✓	✓	✓	✓
System Version	Android 6.0.1 Marshmallow			
CPU	RK3399 Dual-core ARM Cortex A72 and Quad-core ARM Cortex-A53			
Android Resolution	1080p	1080p	1080p	1080p
GPU	Mali-T860	Mali-T860	Mali-T860	Mali-T860
RAM	4G	4G	4G	4G
ROM	16GB	16GB	16GB	16GB
Wi-Fi Enabled	✓	✓	✓	✓
Apps and Android Features				
Note App	✗	✗	✗	✗
Email Out	✓	✓	✓	✓
Cleverstore	✗	✗	✗	✗
Lynx App	✗	✗	✗	✗
Lynx Pro	✓	✓	✓	✓
Clever Message – Digital signage enabled NEW	✓	✓	✓	✓
Dual Pen Mode NEW	✓	✓	✓	✓
Clevershare 2 App NEW	✓	✓	✓	✓
Software				
Lynx	✗	✗	✗	✗
Snowflake	✗	✗	✗	✗
DisplayNote	✗	✗	✗	✗
Montage	✓	✓	✓	✓
LynxPro Meeting	✓	✓	✓	✓
Accessories				
i5 PC Module included (1541041)	✗	✗	✗	✓
USB Camera Ability	✓	✓	✓	✓
Writing Pen or Stylus	2 (EMR Active Pens)	2 (EMR Active Pens)	2 (EMR Active Pens)	2 (EMR Active Pens)
VGA, Audio Cables	✓	✓	✓	✓
HDMI, USB Cables	✓	✓	✓	✓
Clevershare 1541052	2	2	2	2
Clevercable	✓	✓	✓	✗
Smart Personalised Profile Account (Pen Tray & NFC 1541053) NEW	✓	✓	✓	✓

	55" Pro Series HP	65" Pro Series HP	75" Pro Series HP	86" Pro Series HP
Product Code	15455PROHP	15465PROHP	15475PROHP	15486PROHP
Display				
Screen Type	LED	LED	LED	LED
Aspect Ratio	16:09	16:09	16:09	16:09
Resolution	4K Ultra HD	4K Ultra HD	Full HD	4K Ultra HD
Backlight	D-LED	D-LED	D-LED	D-LED
Brightness (cd/m ²)	350	350	350	350
Response Time	8ms	8ms	8ms	8ms
Audio	2 x 12W	2 x 12W	2 x 12W	2 x 12W
Android	✓	✓	✓	✓
Glass	Anti Glare	Anti Glare	Anti Glare	Anti Glare
Super Glide Surface	✓	✓	✓	✓
Contrast Ratio	1200:1	1200:1	1200:1	1200:1
Interactive System				
Touch Points	20	20	20	20
Sensor Type	High Precision IR	High Precision IR	High Precision IR	High Precision IR
Minimum Object Size (mm)	3	3	3	3
Response Time (Touch)	< 15ms	< 15ms	< 15ms	< 15ms
Connectivity				
USB 2.0 / 3.0 / Touch	4 / 2 / 1	4 / 2 / 1	4 / 2 / 1	4 / 2 / 1
HDMI 1.4 In / 2.0 in	0 / 2	0 / 2	0 / 2	0 / 2
DisplayPort in	0	0	0	0
VGA Input	1	1	1	1
HDMI Out	1	1	1	1
CVBS (requires a 3.5mm to 3 x phono socket, not included)	✓	✓	✓	✓
PC-Audio	✓	✓	✓	✓
VGA Output	x	x	x	x
LAN (RJ45)	✓	✓	✓	✓
RS232	✓	✓	✓	✓
Module Slots	2	2	2	2
Power				
Power	250W	300W	450W	500W
Power (in standby)	<0.5W	<0.5W	<0.5W	<0.5W
EU Energy Rating - Efficiency Class	B	A+	C	B
Physical Specifications				
Dimensions W x H x D (mm / ")	1318 x 789 x 103 / 51 57/64 x 31 1/16 x 4 1/16	1537 x 913 x 99 / 60 33/64 x 35 15/16 x 3 57/64	1779 x 1032 x 100 / 70 3/64 x 40 5/8 x 3 15/16	2004 x 1176 x 99.6 / 78.9 57/64 x 46 19/64 x 3 59/64
Weight	36.5kg / 80lb 7.4oz	49kg / 108lb	57.8kg / 127lb 6.8oz	73.7kg / 162lb 8oz
VESA (mm / ")	400 x 400 / 15 3/4 x 15 3/4	600 x 400 / 23 5/8 x 15 3/4	800 x 400 / 31 1/2 x 15 3/4	800 x 600 / 31 1/2 x 23 5/8
Android Capabilities				
Remote Management (MDM)	✓	✓	✓	✓
Instant updates (OTA)	✓	✓	✓	✓
System Version	Android 6.0.1 Marshmallow			
CPU	RK3399 Dual-core ARM Cortex A72 and Quad-core ARM Cortex- A53			
Android Resolution	1080p	1080p	1080p	1080p
GPU	Mali-T860	Mali-T860	Mali-T860	Mali-T860
RAM	4G	4G	4G	4G
ROM	16GB	16GB	16GB	16GB
Wi-Fi Enabled	✓	✓	✓	✓
Apps and Android Features				
Note App	x	x	x	x
Email Out	✓	✓	✓	✓
Cleverstore	x	x	x	x
Lynx App	x	x	x	x
Lynx Pro	✓	✓	✓	✓
Clever Message - Digital signage enabled NEW	✓	✓	✓	✓
Dual Pen Mode NEW	✓	✓	✓	✓
Clevershare 2 App NEW	✓	✓	✓	✓
Software				
Lynx	x	x	x	x
Snowflake	x	x	x	x
DisplayNote	x	x	x	x
Montage	✓	✓	✓	✓
LynxPro Meeting	✓	✓	✓	✓
Accessories				
i5 PC Module included (1541041)	x	x	x	x
USB Camera Ability	✓	✓	✓	✓
Writing Pen or Stylus	2	2	2	2
VGA, Audio Cables	✓	✓	✓	✓
HDMI, USB Cables	✓	✓	✓	✓
Clevershare 1541052	x	x	x	x
Cleverbable	x	x	x	x
Smart Personalised Profile Account (Pen Tray & NFC 1541053) NEW	x	x	x	x

65" Pro Series | E-CAP

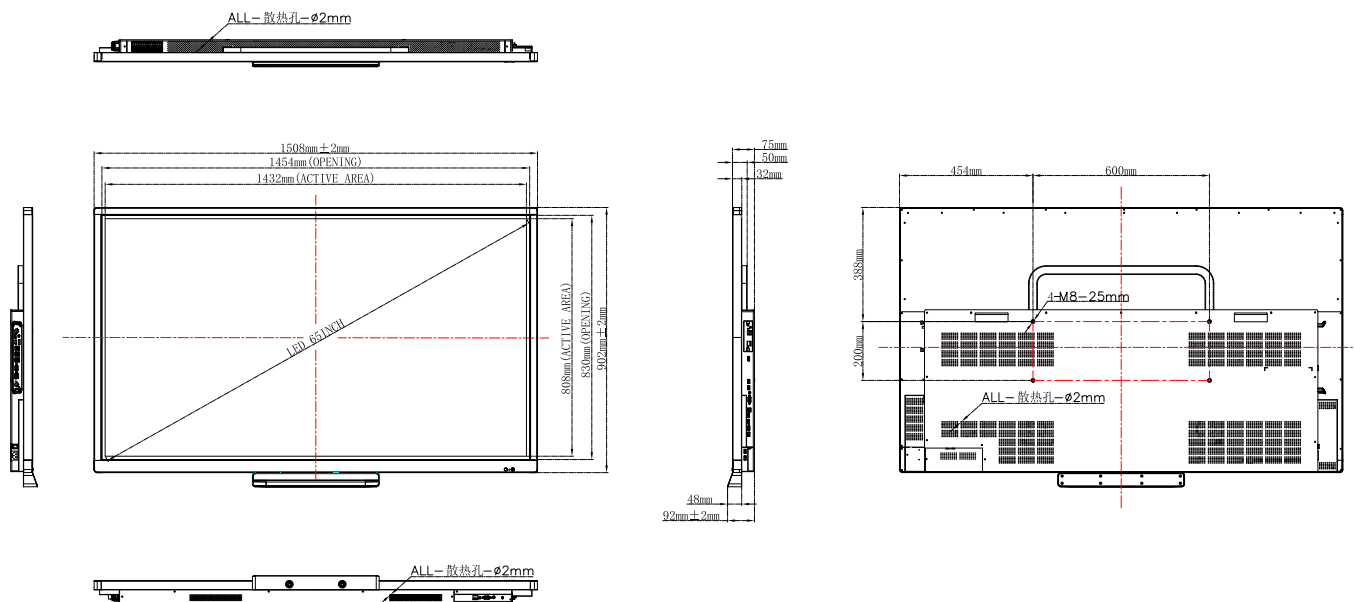

75" Pro Series | E-CAP

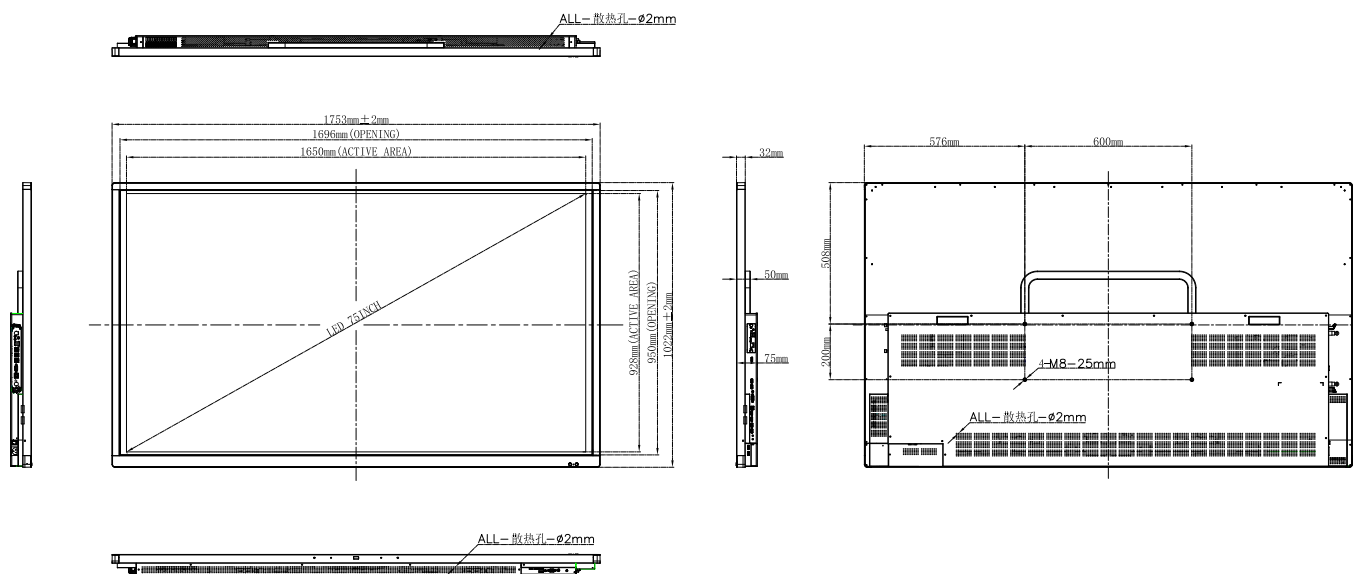

86" Pro Series | E-CAP

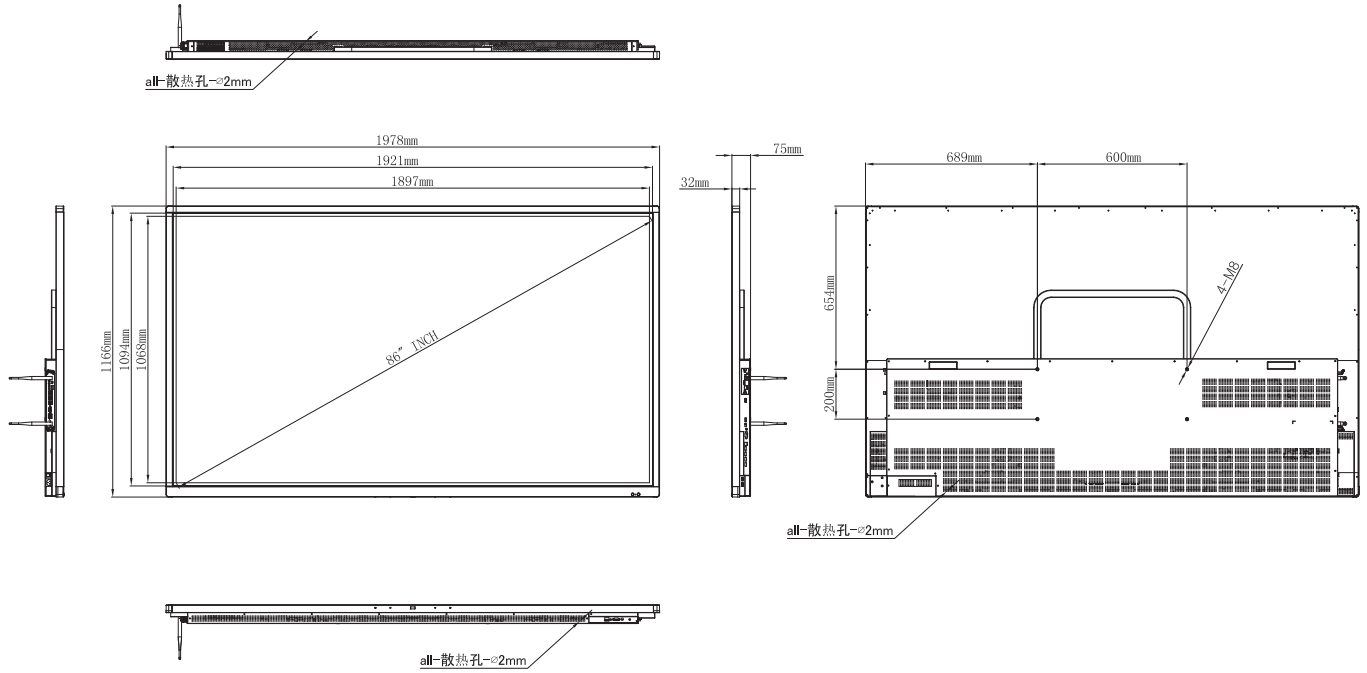

65" Capacitive Touch

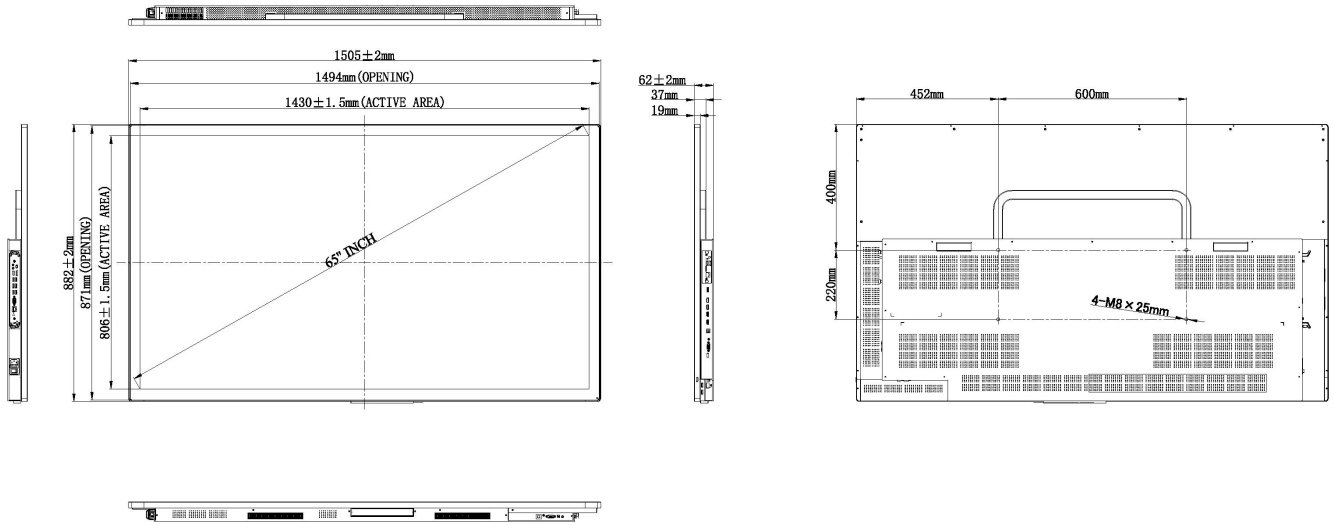

55" Pro Series | HP

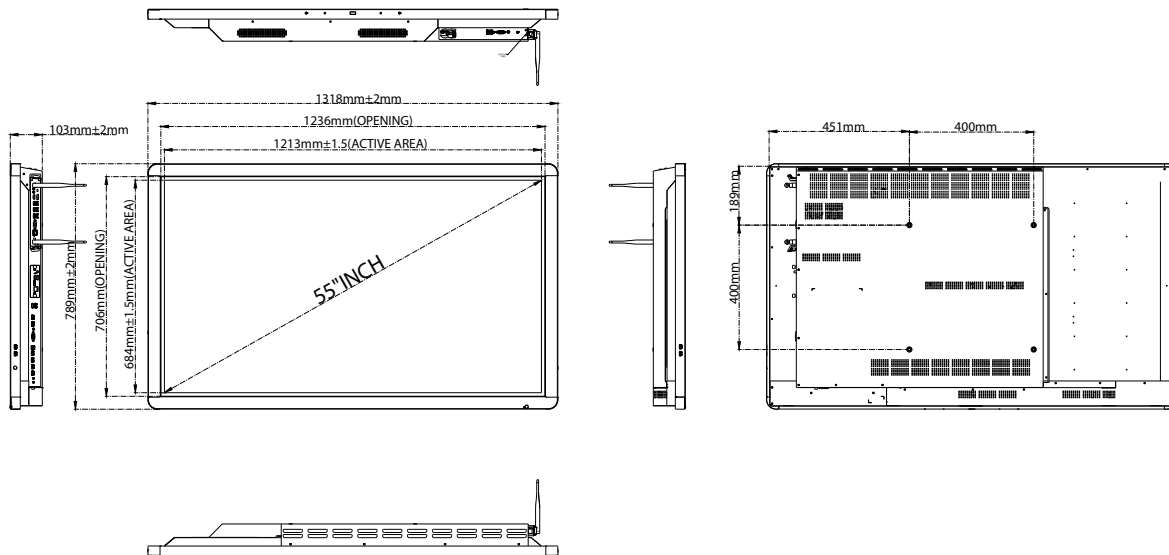

65" Pro Series | HP

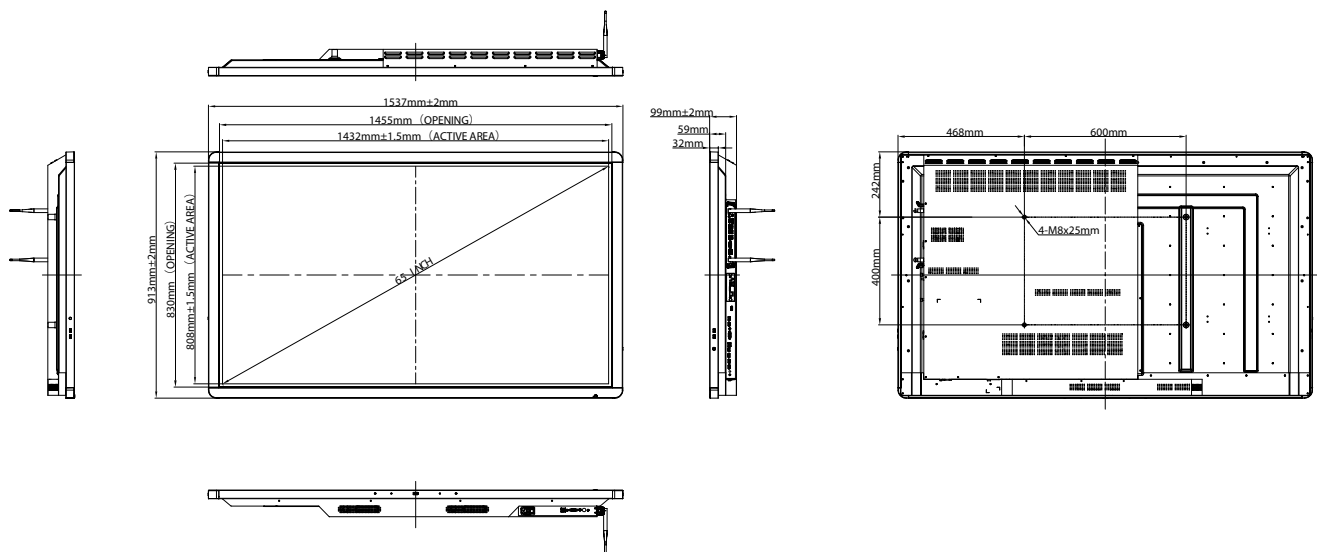

75" Pro Series | HP

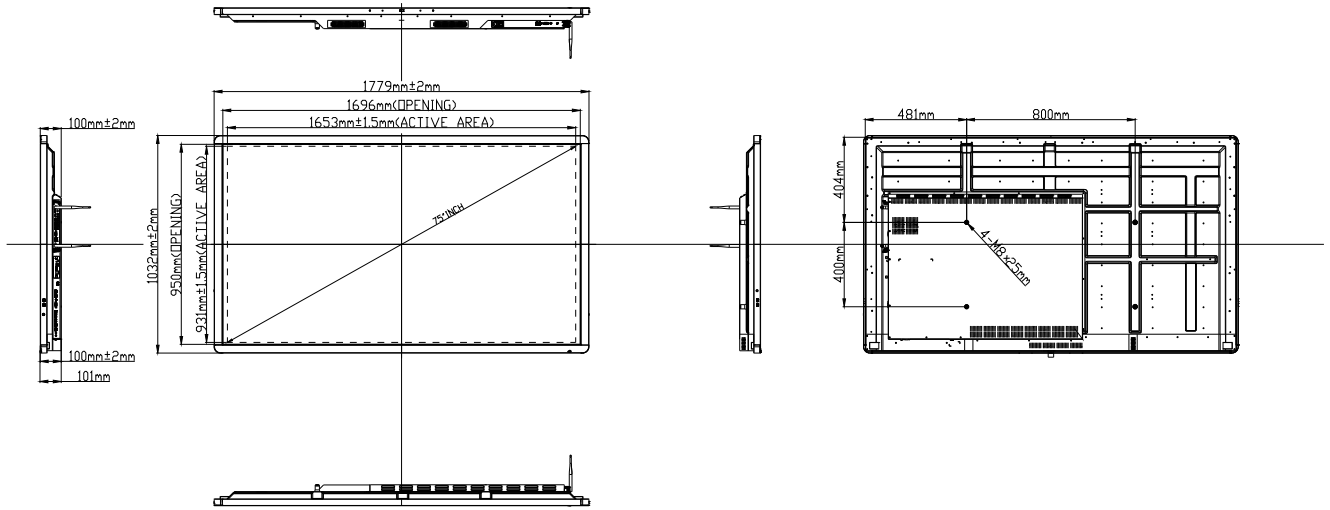

86" Pro Series | HP

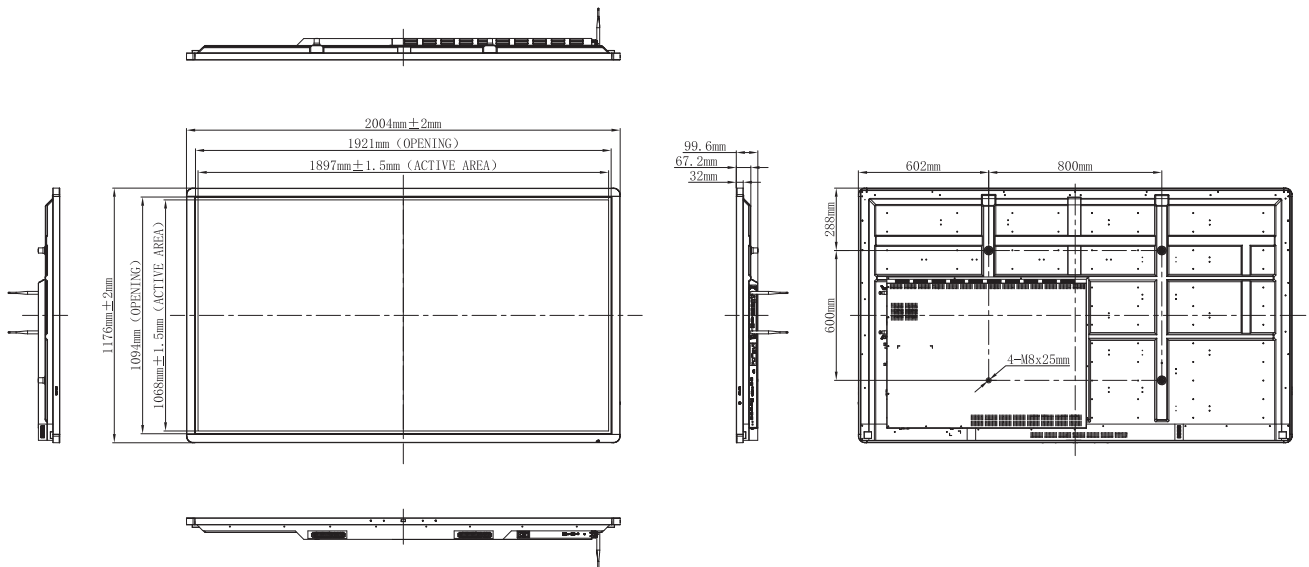

Clevertouch PC Modules



i5 PC Module

Product Code
1541041

i7 PC Module

Product Code
1541042

PC		
Type	PC Module	PC Module
Model	MT21	MT21
CPU	Intel® Core™ i5	Intel® Core™ i7
RAM	DDR4 4Gb	DDR4 8Gb
SSD	128Gb	256Gb
Graphics	Integrated Intel® HD Graphics/Independent Graphics	Integrated Intel® HD Graphics/Independent Graphics
Chipset	Intel H110 Express	Intel H110 Express
Sound Card	Integrated High Definition Audio Stereo	Integrated High Definition Audio Stereo
Networking	Integrated 10/100/1000M Adaption	Integrated 10/100/1000M Adaption
WIFI	802.11ac (2.4GHz/5GHz)	802.11ac (2.4GHz/5GHz)
Operation System	Windows 10 Pro installed	Windows 10 Pro installed
USB3.0	6	6
LAN(RJ45)	1	1
VGA Output	1	1
Earphone Output	1	1
Microphone Input	1	1
Display Port	1	1
HDMI Output	1	1
Power		
Power Supply Mode	Internal Power Supply Module	Internal Power Supply Module
Power Requirements	100-240V~ 50/60Hz	100-240V~ 50/60Hz
Max Power	95W	95W
Standby Power	1.35W	1.35W
Physical Specs		
Cover Material	SECC	SECC
Dimension L x W x H	246.2 x 265.4 x 32.2mm	246.2 x 265.4 x 32.2mm
Net Weight	1.9kg	1.9kg
Environmental Conditions		
Operation Temperature	0°C – 45°C	0°C – 45°C
Operation Humidity	10% – 90%	10% – 90%
Storage Temperature	-20°C – 60°C	-20°C – 60°C
Storage Humidity	10% – 90%	10% – 90%
ESD		
Contact Discharge	±4KV passed level A test(CB)/ ±6KV passed level B test(CB)	±4KV passed level A test(CB)/ ±6KV passed level B test(CB)
Non-contact Discharge	10% ±8KV passed level A test(CB)/ ±12KV passed level B test(CB)	10% ±8KV passed level A test(CB)/ ±12KV passed level B test(CB)

Clevershare Wireless Device



Wirelessly transmits Video, Audio and Touch

With the Clevershare wireless device you can control your Clevertouch from anywhere in the room, without the need for any wires. Simply plug the Clevershare into your laptop's USB port and you can show and edit your laptop's content on your Clevertouch screen. You can instantly display your desktop and control from your computer or Clevertouch – your pen or finger becomes your mouse.

Product Features

- Simple operation, one button projection
- Up to eight computers can be connected at the same time
- The USB data interface applies to all computers
- Windows and Mac OS compatible
- Low power consumption, no additional power supply
- Exclusive to Plus Series and Pro Series

Security Features

- Clevershare uses a “private” SSID that is only accessible between the receiver (Clevertouch IFP) and transmitter (dongle), this connection is setup when the dongle is paired with the Clevertouch
- The SSID uses the WPA2 encryption (based on 128bit AES) on the transport layer, but no data encryption on the application layer
- Since the video transfer is not on a public network, no other clients are allowed to join in
- The video transfer should be regarded as secure

Clevercable

Clevercable is the hardwired version of our Clevershare technology and enables sharing on Windows & Mac to your Clevertouch via the USB port. Clevercable comes as standard with every purchase of a Pro Series screen.

Product Features

- Quick and hassle free set up
- Provides reverse touch control
- Includes one-button click for instant sharing
- 5 metre cable
- Secure

Interface

USB 2.0 1

Function

Operating Systems supported Windows 7/8/8.1/10; OSX 10.9/10.10/10.11

Frame Rate 15-20fps
Windows 7/8/10 1366x768 @ 15-20fps
Windows 7/8/10 1920x1080 @ 15-20fps
Mac-Bit rate (600KB) @ 25fps
Mac-Bit rate (300KB) @ 20fps

Power

Power Consumption 2.5W

Transmitter Power 16mW

Physical Specifications

Dimensions L x H x W (mm / ") 77 x 178.7 x 21.3 / 7 23/64 x 1 7/64 x 0 15/16

Dimensions (Package) L x H x W (mm / ") 210 x 44 x 111 / 8 17/64 x 4 3/8 x 1 47/64

Net Weight 86g

Gross Weight 195g



Interface

USB 2.0-A 1

USB 2.0-B 1

Hardware

Indicator Light Indicator transmission status

Resolution 1920 x 1080 @ 60Hz

System Windows 7/8/8.1/10, Mac OS X 10.9 and above

Transmission Distance 5m

Power

Power Requirements 5V DC

Power Consumption ≤2.5W

Physical Specifications

Dimensions L x H x W (mm / ") 187 x 28 x 24 / 3 1/32 x 7 1/64 x 0 27/32

Dimensions (Package) L x H x W (mm / ") 210 x 111 x 44 / 8 17/64 x 1 47/64 x 4 3/8

Net Weight 35g

Gross Weight 550g

65" Pro Series | E-CAP

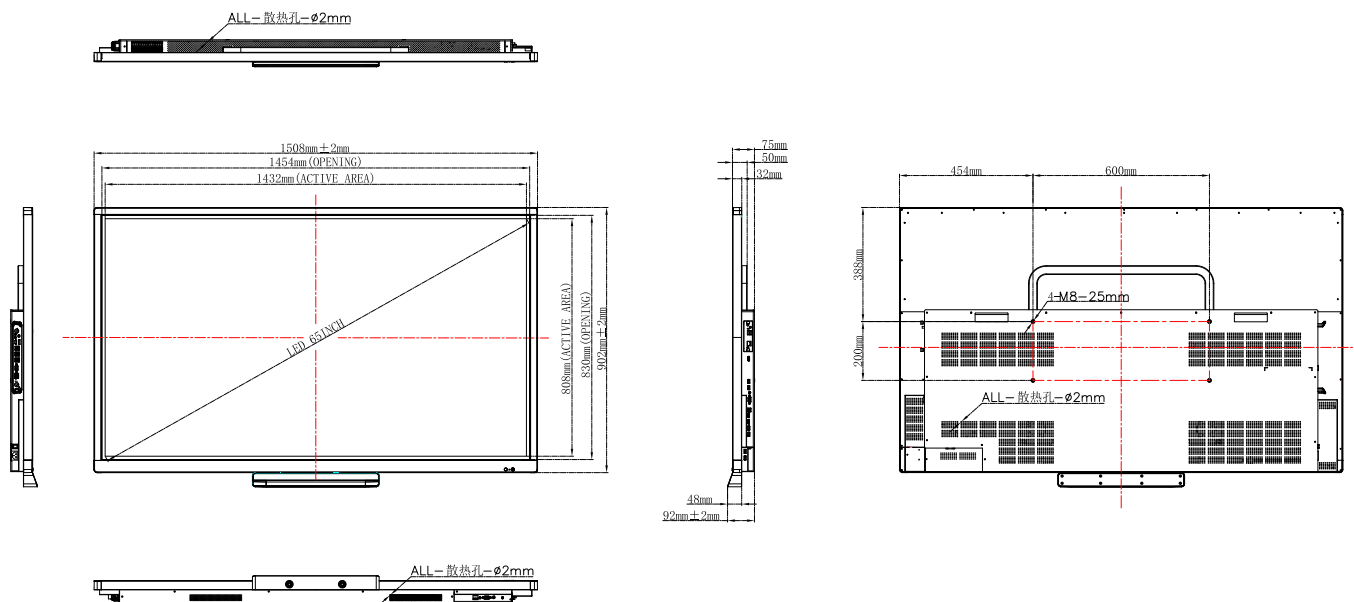

75" Pro Series | E-CAP

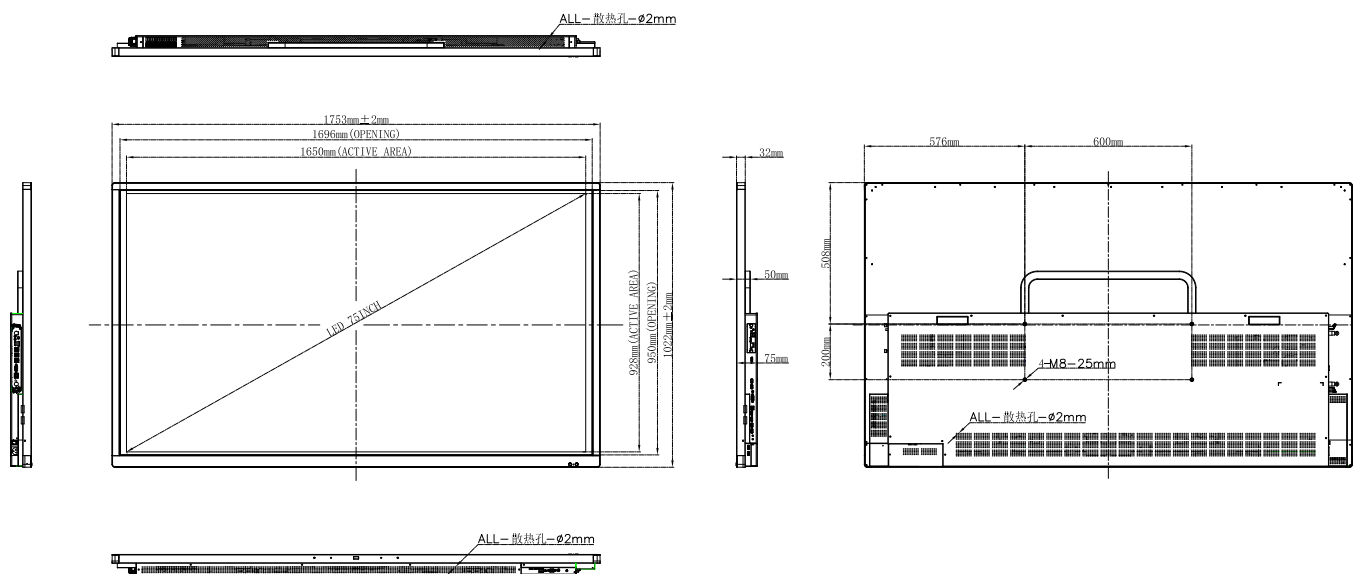

86" Pro Series | E-CAP

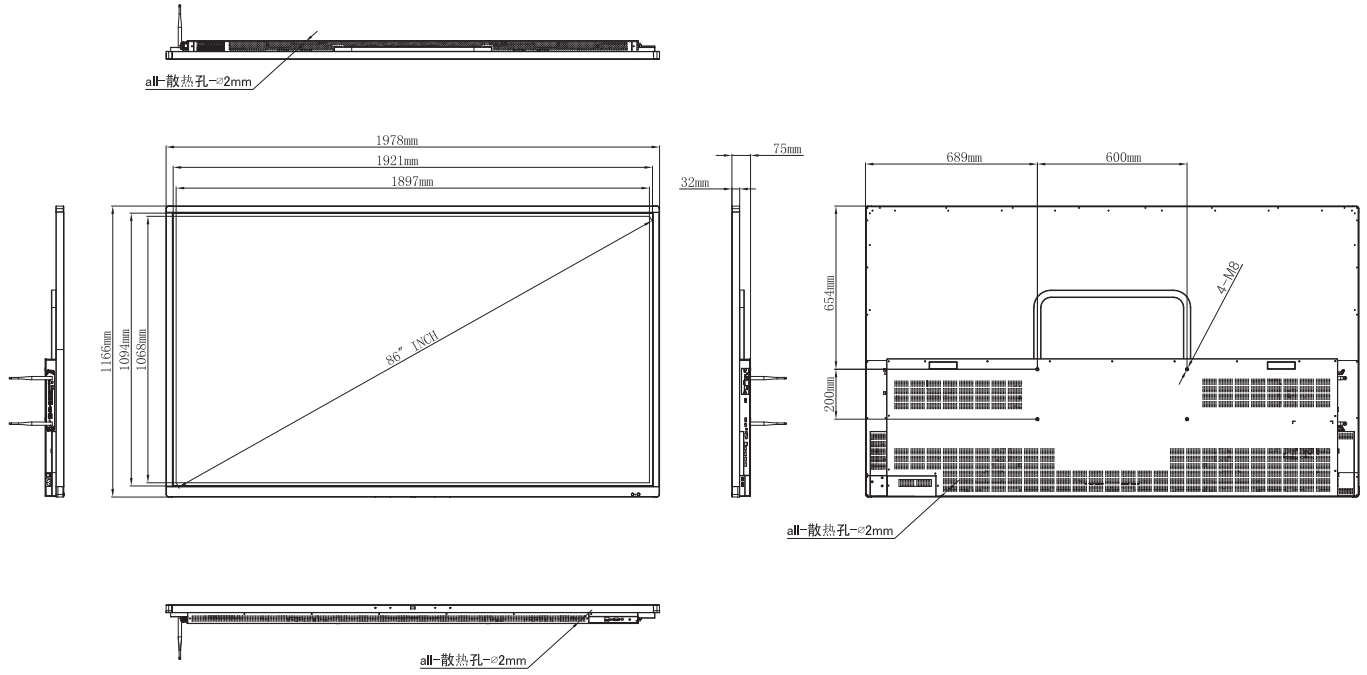

65" Capacitive Touch

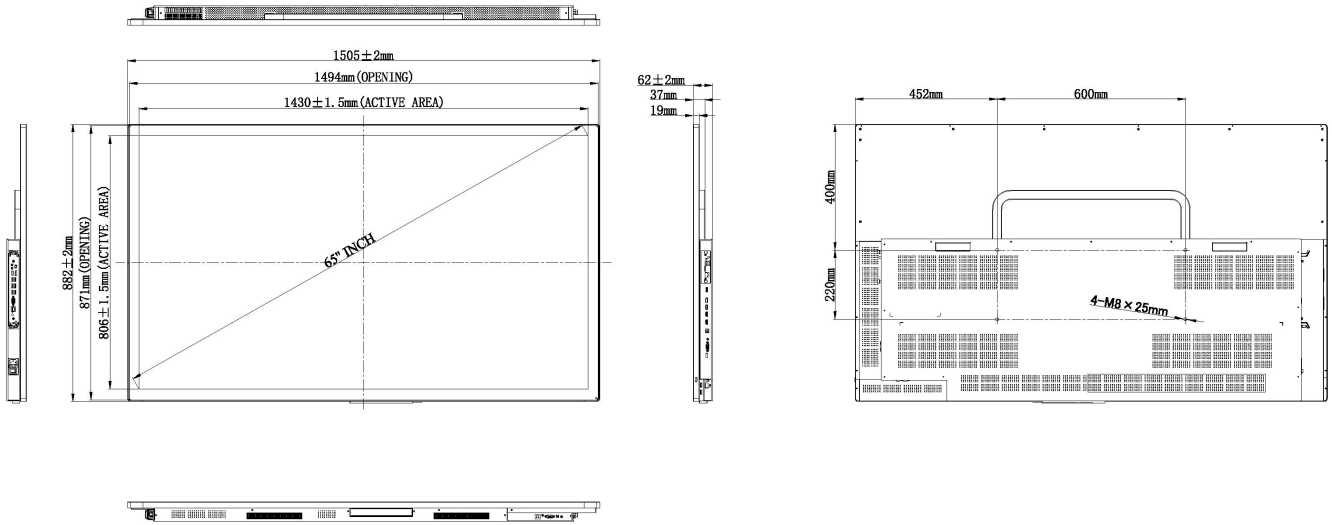

55" Pro Series | HP

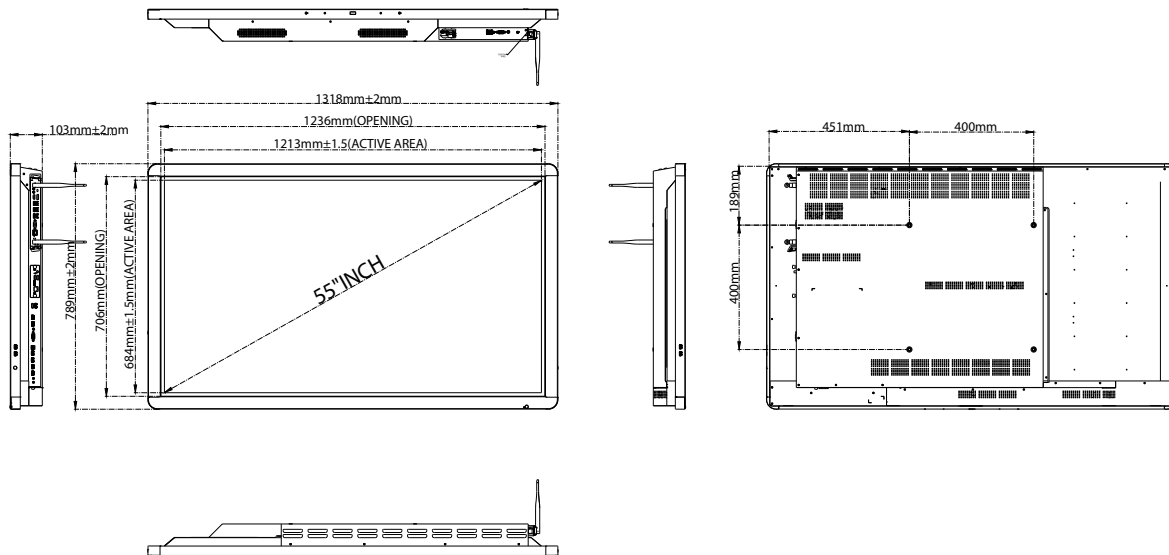

65" Pro Series | HP

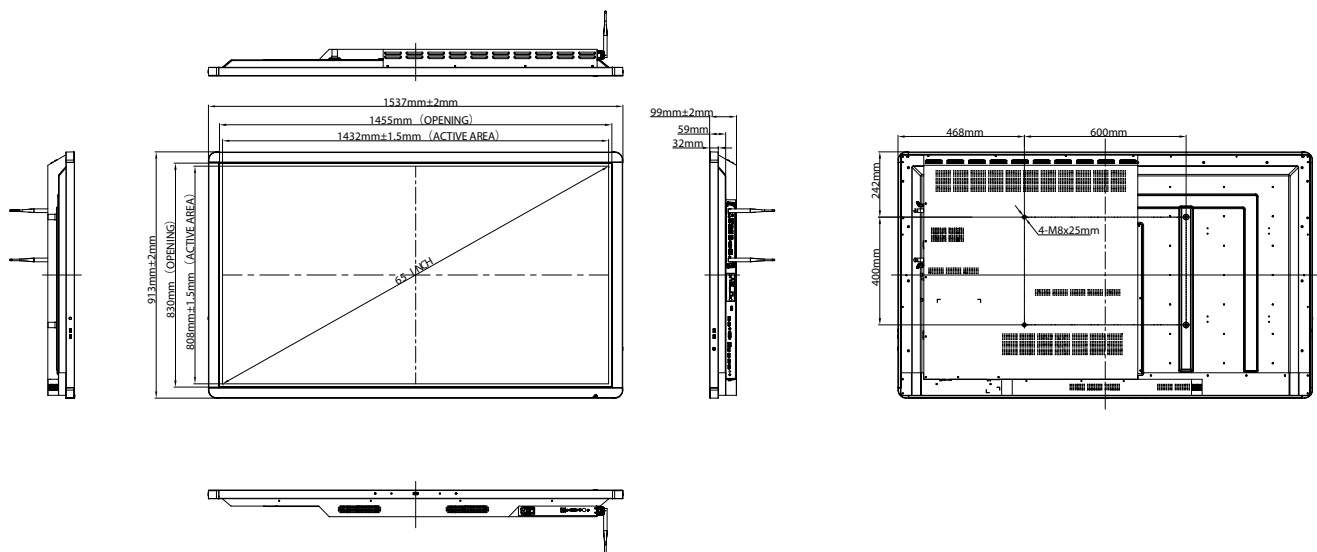

75" Pro Series | HP

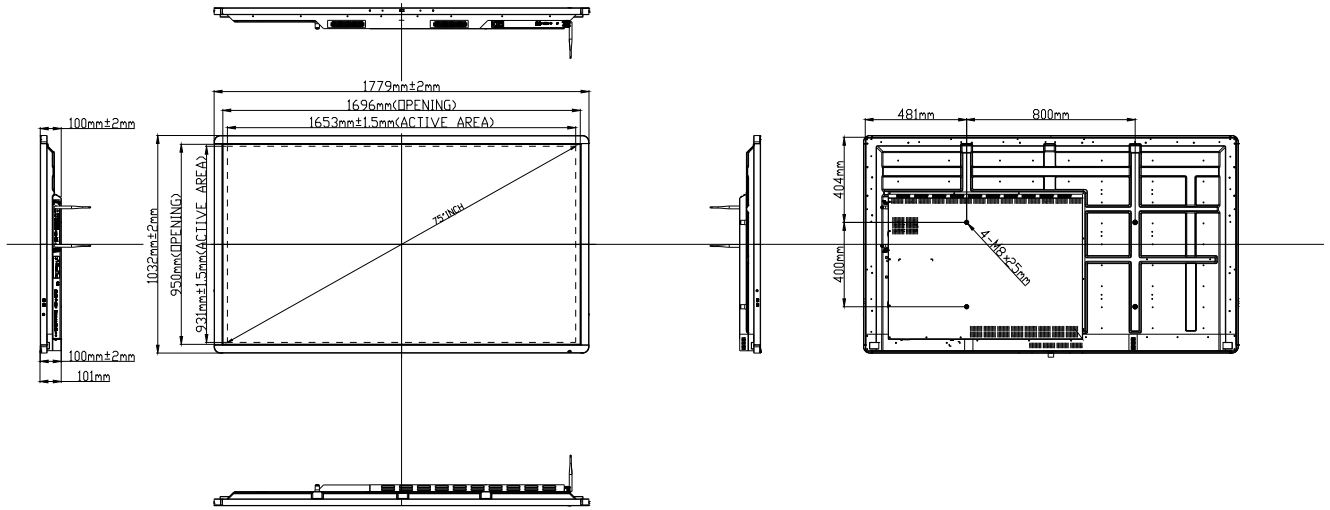

86" Pro Series | HP

